

## INSTRUCTION MANUAL

VHF AIR BAND TRANSCEIVER

# IC-A3

# IC-A3E

This device complies with Part 15 of the FCC Rules. Operation is subject to the condition that this device does not cause harmful interference.

Icom Inc.



---

## IMPORTANT

---

**READ ALL INSTRUCTIONS** carefully and completely before using the transceiver.

**SAVE THIS INSTRUCTION MANUAL** – This instruction manual contains important safety and operating instructions for the IC-A3 and IC-A3E.

---

## CAUTIONS

---

**12 V ONLY! NEVER** connect the transceiver to a 24 V socket or to an AC outlet. More than 15 V DC will damage the transceiver.

**NEVER** connect the transceiver to a power source using reverse polarity. This connection will ruin the transceiver.

**NEVER** allow children to touch the transceiver.

**AVOID** using or placing the transceiver in direct sunlight or in areas with temperatures below  $-10^{\circ}\text{C}$  ( $+14^{\circ}\text{F}$ ) or above  $+60^{\circ}\text{C}$  ( $+140^{\circ}\text{F}$ ).

---

## EXPLICIT DEFINITIONS

---

WORD	DEFINITION
CAUTION	Equipment damage may occur.
NOTE	If disregarded, inconvenience only. No risk of personal injury, fire or electric shock.

**BE CAREFUL!** When transmitting for a long time, the rear panel will become hot.

**BE CAREFUL!** During external DC power operation, the connected Ni-Cd battery pack is charged.

**BE CAREFUL!** The use of non-Icom battery packs and chargers may impair transceiver performance and invalidate the warranty.

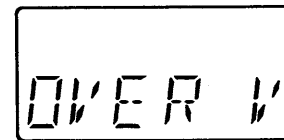

Unplug the external DC plug immediately when "OVER V" is displayed as shown at left, indicating more than approx. 18 V DC is connected.

# TABLE OF CONTENTS

IMPORTANT .....	i
CAUTIONS .....	i
EXPLICIT DEFINITIONS .....	i
TABLE OF CONTENTS .....	ii
UNPACKING .....	ii
<b>1 PANEL DESCRIPTION .....</b>	<b>1-4</b>
■ Front and side panels .....	1
■ Top panel .....	2
■ Keypad .....	3
■ Function display .....	4
<b>2 PRE-OPERATION .....</b>	<b>5-8</b>
■ Battery pack charging .....	5
■ Battery pack precautions .....	5
■ About the battery pack .....	5
■ Charging connections .....	6
■ External power source connection ..	7
■ Alkaline battery installation .....	7
■ Accessory attachment .....	8
<b>3 BASIC OPERATION .....</b>	<b>9-11</b>
■ Accessing the 121.5 MHz emergency frequency .....	9
■ Setting a frequency .....	9
■ Lock function .....	10

■ Selecting a weather channel .....	10
■ Receiving .....	11
■ Transmitting .....	11
■ Side tone function .....	11
<b>4 MEMORY OPERATION .....</b>	<b>12-14</b>
■ Memory channel selection .....	12
■ Transferring memory contents .....	12
■ Programming a memory channel .....	13
■ Programming a comment .....	13
■ Clearing memory contents .....	14
<b>5 SCAN OPERATION .....</b>	<b>15-16</b>
■ Scan types .....	15
■ Full scan .....	15
■ Memory scan .....	15
■ Weather channel scan .....	16
■ Lockout channels .....	16
<b>6 TROUBLESHOOTING .....</b>	<b>17</b>
<b>7 MODE ARRANGEMENT CHART .....</b>	<b>18</b>
<b>8 SPECIFICATIONS .....</b>	<b>19</b>
<b>9 OPTIONS .....</b>	<b>20</b>

# UNPACKING

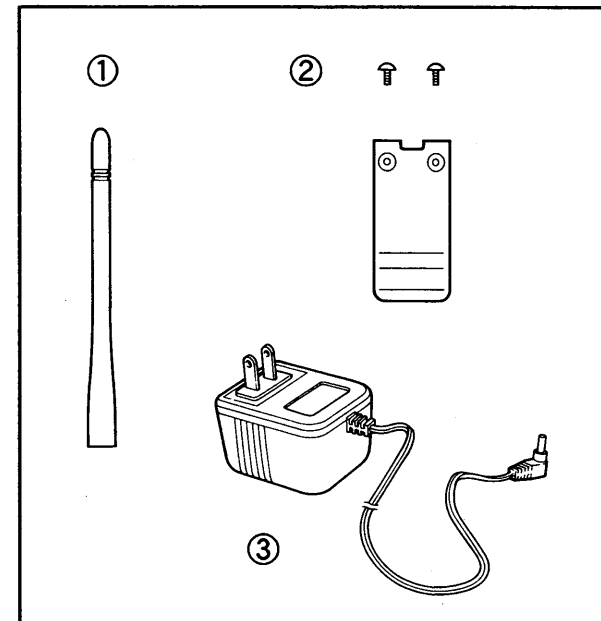

Included accessories:	Qty.
① Antenna (FA-B01AR) .....	1
② Belt clip and screws .....	1 set
③ Wall charger* .....	1
Battery pack* (CM-166) (attached to the transceiver) .....	1

\* Some versions do not include the wall charger and battery pack. The Australia version includes the OPC-507 JACK ADAPTER.

## Front and side panels

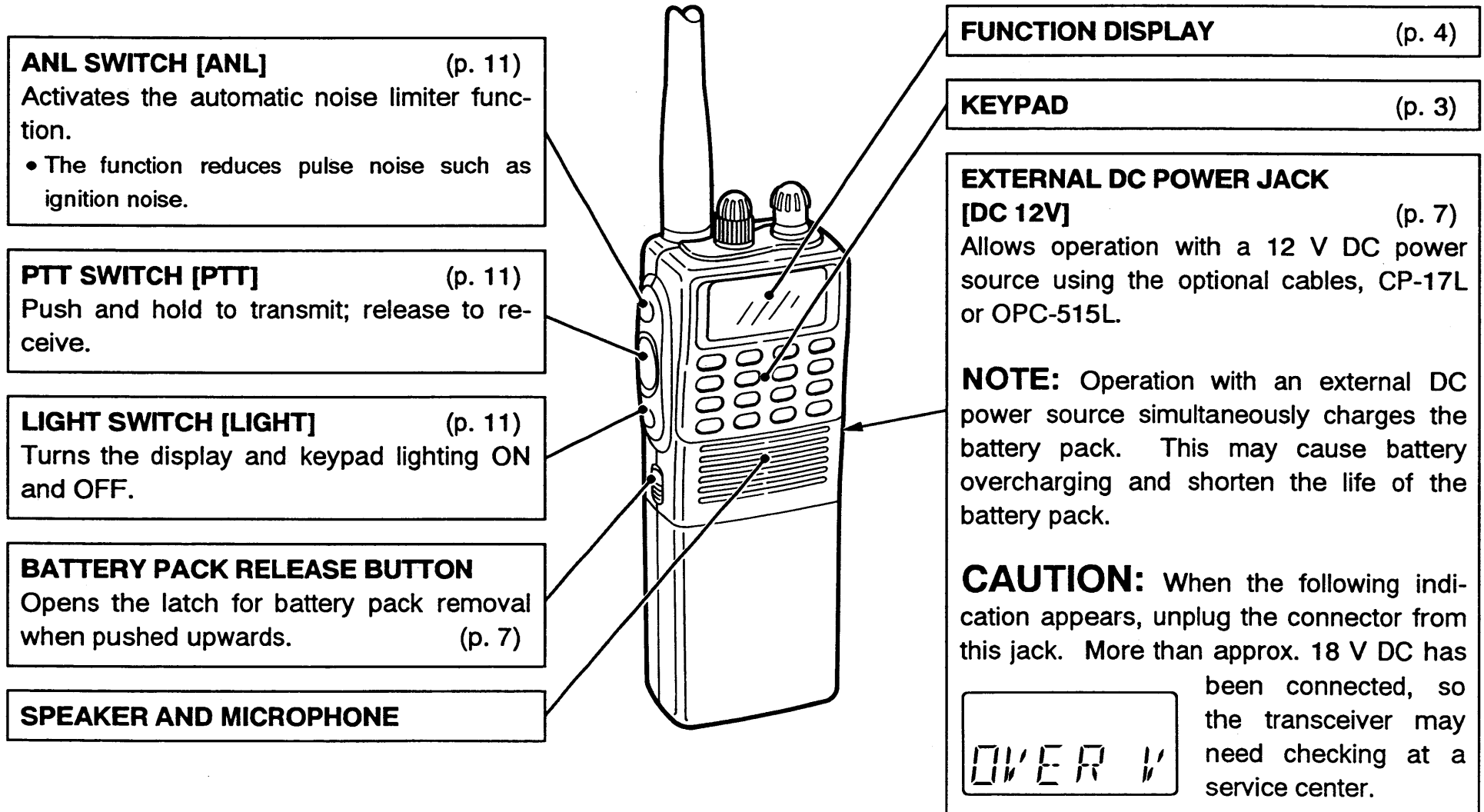

## ■ Top panel

**ANTENNA CONNECTOR** (p. 8)  
Connects the supplied antenna.

**VOLUME CONTROL [VOL]** (p. 11)  
Turns the power ON and OFF, and adjusts the audio level.

**SQUELCH CONTROL [SQL]** (p. 11)  
Varies the squelch threshold point for noise mute.

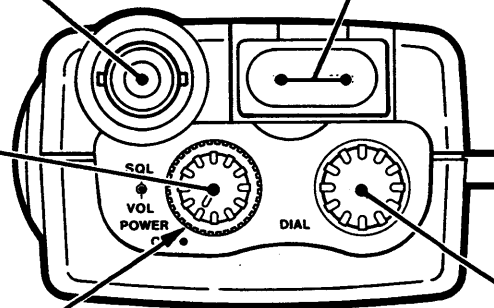

**EXTERNAL SPEAKER AND MICROPHONE JACKS [SP]/[MIC]**

Connect a headset of the David Clark Co. via optional OPC-499, if desired. The transmit voice can be monitored from the headset. The internal speaker will not function when connected.







**TUNING DIAL [DIAL]**

- Sets an operating frequency, memory channel or weather channel.\*
  - Sets the 1 MHz digit after pushing [F] in frequency mode.
- \* Weather channel: U.S.A. version only.

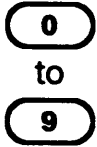







# 1 PANEL DESCRIPTION

## ■ Keypad

### ◇ Primary functions

KEY	FUNCTION
	- Sets the desired frequency. (p. 9) - Selects the desired character for memory channel comments while programming a memory channel. (p. 13)
	- Clears the input digit before entry. (p. 9) - Exits the memory channel or weather* channel. (p. 18)
UP SCAN  DN SCAN 	- Changes the frequency or memory channel when pushed. (pgs. 9, 12) - Changes the frequency or memory channel continuously when pushed and held. (pgs. 9, 12)
WX 	Enters numeral input. Enters "0" into the remaining digits. (p. 9)
MW 	- Selects memory mode. (p. 12) - Changes between the memory channel comments and frequency display. (p. 12)
	Activates the secondary functions of keys and the tuning dial. See the right table for details. The function is automatically cancelled after 3 sec.

### ◇ Secondary functions

KEY	FUNCTION AFTER PUSHING [F]
KEY LOCK 	Turns the lock function ON and OFF after pushing [F]. (p. 10)
BEEP 	Turns the beep tone ON and OFF after pushing [F]. (p. 11)
LOCK OUT 	Sets the displayed memory or weather* channel as a lockout channel after pushing [F]. (p. 16)
121.5 	Selects the 121.5 MHz emergency frequency after pushing [F]. (p. 9)
WX 	Selects a weather channel* after pushing [F]. (p. 10)
MW 	- Programs a memory channel in frequency mode. (p. 13) - Transfers a memory channel's contents in memory mode. (p. 12)
UP SCAN DN SCAN  	Starts the full scan, memory scan or weather channel* scan. (p. 15)
	Clears a memory channel's contents when pushed and held after pushing [F]. (p. 14)

\* Weather channel: U.S.A. version only.

## ■ Function display

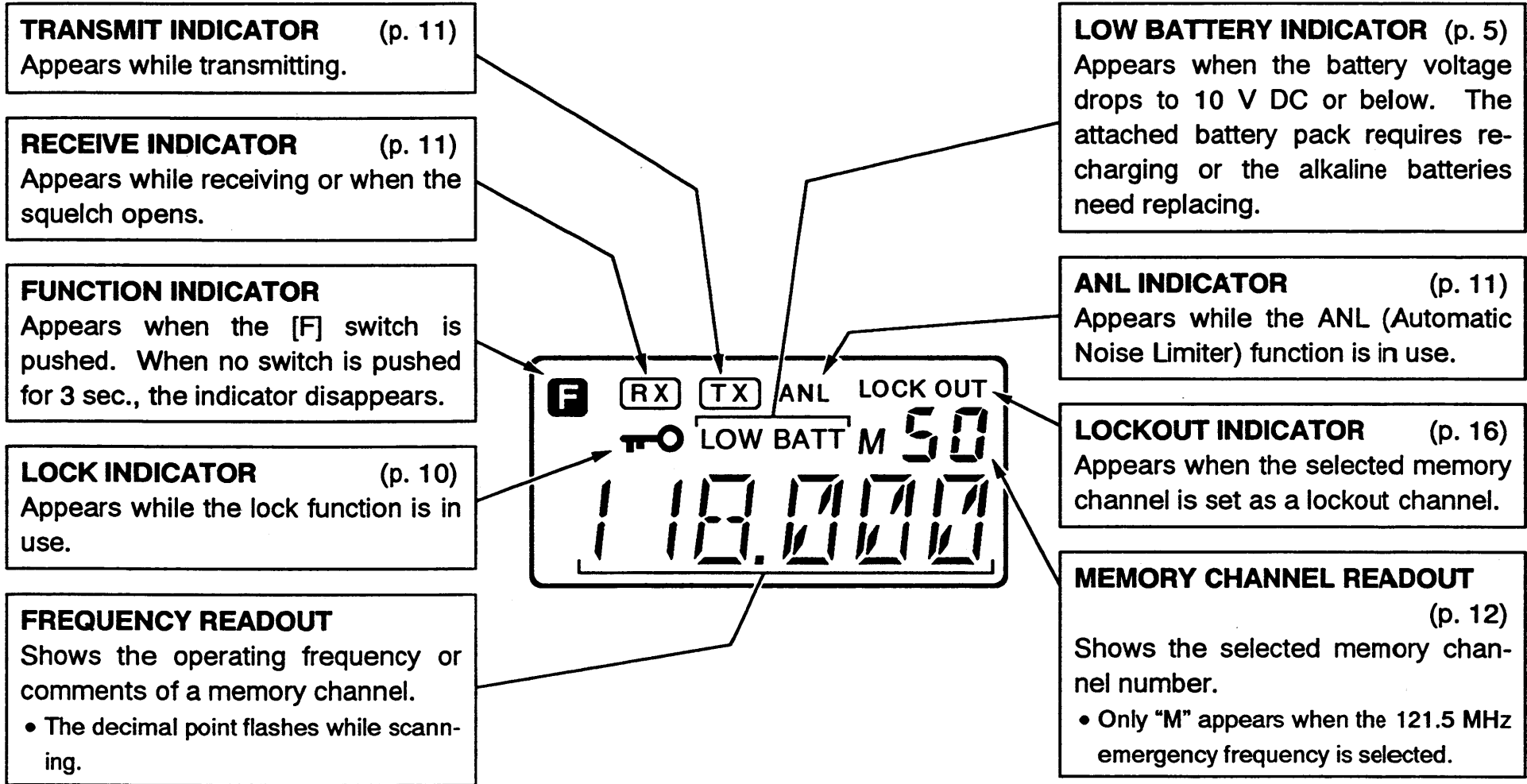

## ■ Battery pack charging

Charge the battery pack before first operating the transceiver and when the low battery indicator appears.

## ■ Battery pack precautions

**NEVER** throw a battery pack into a fire.

**NEVER** expose the battery pack to water.

**NEVER** short the metal terminals of a battery pack.

**DO NOT** attempt to charge a fully charged battery pack.

**DO NOT** discharge a battery pack completely.

**AVOID** overcharging. Disconnect the wall charger or power cable within 48 hrs.

Charging may not occur in extreme cold (under 0°C; +32°F) or extreme heat (over +40°C; +104°F).

## ■ About the battery pack

### ◇ Operating periods

Operating period of the CM-166 (12 V, 600 mA) is approx. 5 hours.

**CONDITION:** 5% Tx / 5% Rx / 90% Standby (squelched). Operating period is estimated values and vary depending on output power, temperature, etc.

### ◇ Battery memory effect

Full charge capacity may become lower when repeatedly recharging after only partial discharging. If this occurs, discharge almost completely through normal use before recharging.

### ◇ Battery pack life

When the operating period becomes extremely short even after charging the battery pack fully, a new battery pack is needed.

### ◇ Recycling information (U.S.A. only)



The product that you have purchased contains a rechargeable battery. The battery is recyclable. At the end of its useful life, under various state and local laws, it may be illegal to dispose of this battery into the municipal waste stream. Check with your dealer or local solid waste officials for details in your area for recycling options or proper disposal.



## ■ Charging connections

### ◇ Regular charging without transceiver

Connect the wall charger to the charger jack on the side panel of the CM-166. Some versions require an adapter cable for connection.

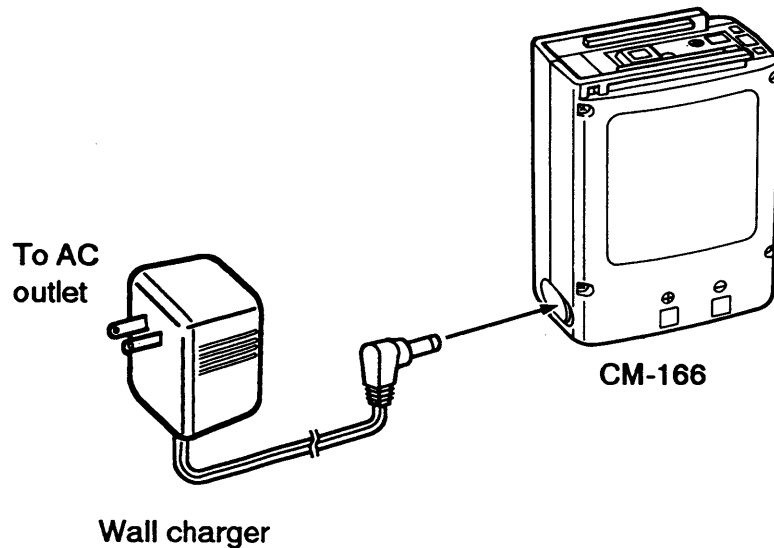

Approx. charging period: 15 hrs.

While connecting the wall charger, **DO NOT** connect any cable to the transceiver's [DC 12V] jack.

### ◇ Rapid charging with the optional BC-79

- ① Insert the optional AD-50 DESKTOP CHARGER ADAPTER into the charging slot of the BC-79 DESKTOP CHARGER.
- ② Firmly insert a battery pack into the AD-50.

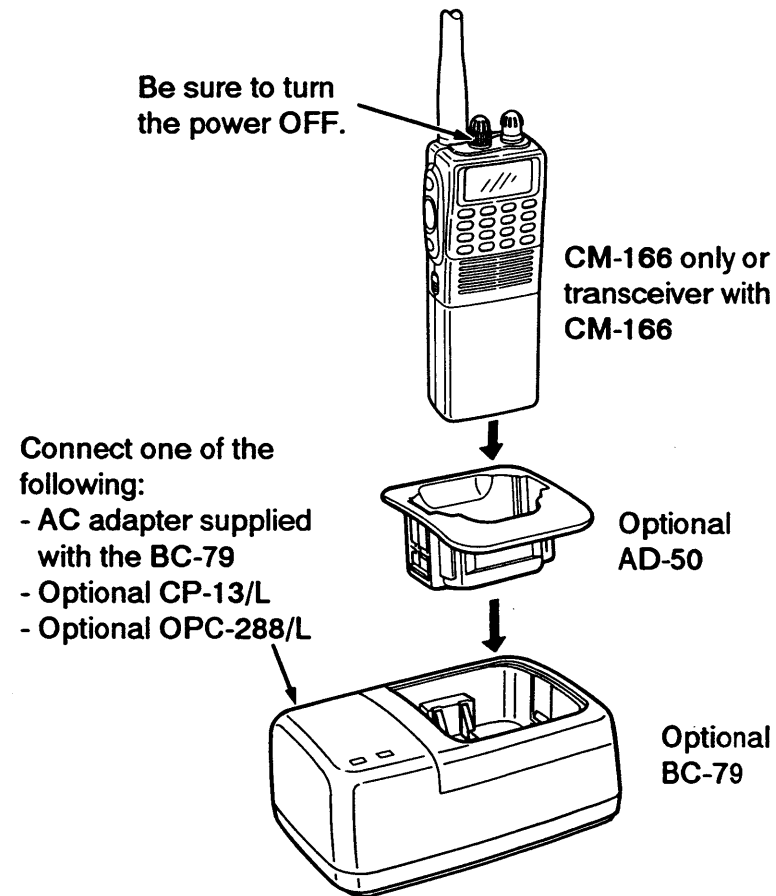

Approx. charging period: 1.5 hrs.

## 2 PRE-OPERATION

### External power source connection

An optional CP-17L CIGARETTE LIGHTER CABLE is available to operate the IC-A3 with a 12 V cigarette lighter socket.

The attached Ni-Cd battery pack is charged in approx. 15 hrs. simultaneously. While connecting an external power source, **DO NOT** connect the wall charger to the CM-166.

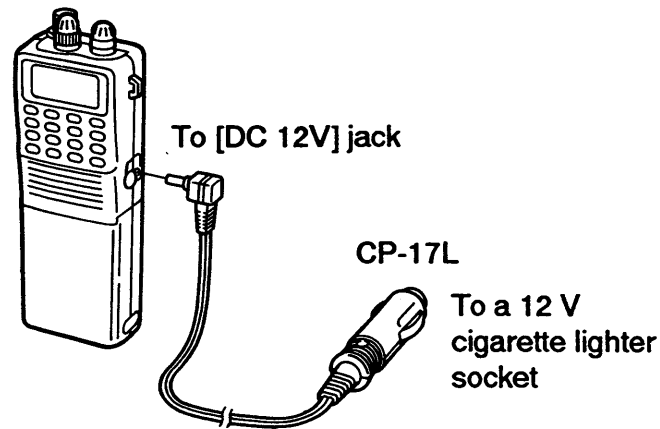

The OPC-515L DC POWER CABLE with a 12 V DC power supply can be used instead of the CP-17L.

### Alkaline battery installation

An optional CM-167 BATTERY CASE is available. Install ten alkaline batteries as follows.

- ① Push and hold the battery release button upwards, then slide the battery case to the right with the transceiver facing you. (Fig. 1)
- ② Open the battery case. (Fig. 2)
- ③ Install 10 alkaline batteries. (Fig. 3)
  - Pay attention to the polarities.

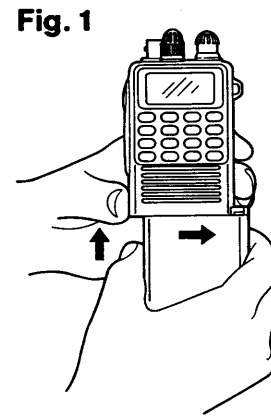

Fig. 2

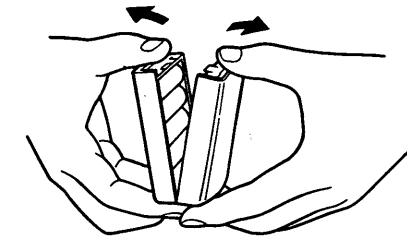
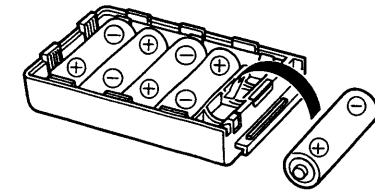

Fig. 3



## ■ Accessory attachment

### ◇ Antenna

Connect the supplied flexible antenna into the antenna connector and rotate clockwise.

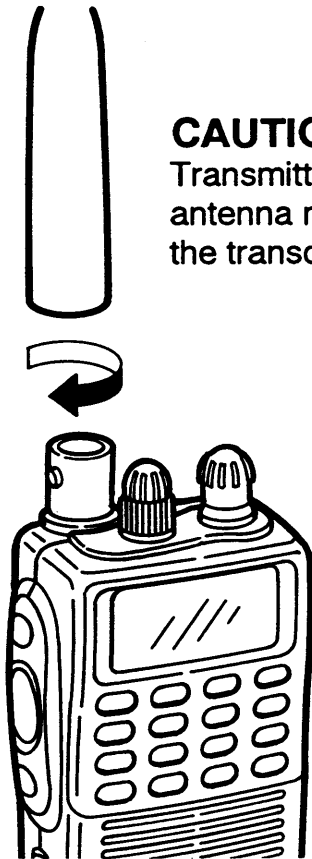

**CAUTION:**  
Transmitting without the antenna may damage the transceiver.

### ◇ Belt clip

Remove the plastic screws, then attach the belt clip with the supplied metal screws. Conveniently attaches to your belt.

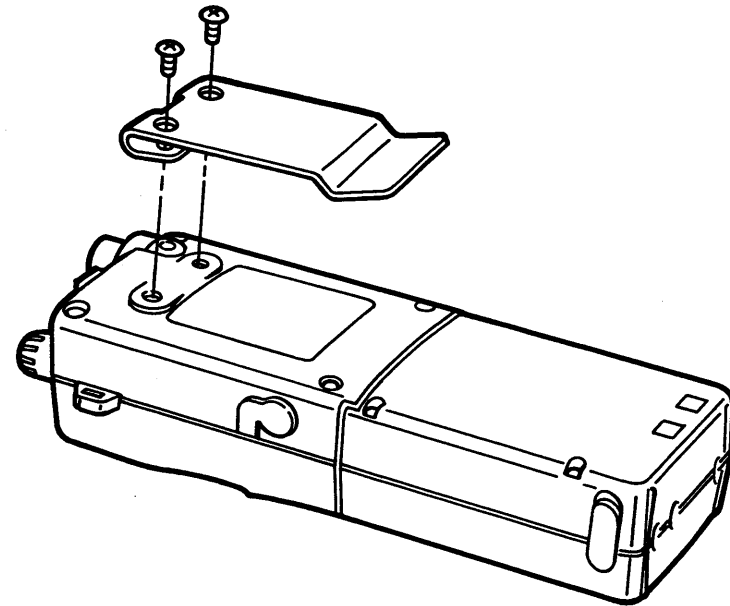

## ■ Accessing the 121.5 MHz emergency frequency

The IC-A3 can quickly access the 121.50 MHz emergency frequency. This function can be activated even when the keypad lock function is in use. (p. 10)

- ① Rotate [VOL] to turn power ON.
- ② Push [F] on the keypad.
  - “**F**” appears.
- ③ Push [Ⓜ 121.5] to call the emergency frequency.
- ④ Push [CLR] to exit from the emergency frequency.

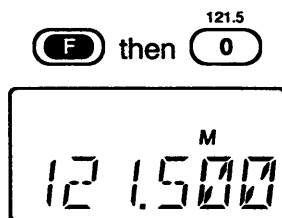

## ■ Setting a frequency

### ◇ Using the keypad

- ① Rotate [VOL] to turn power ON.
- ② Push [CLR] to select frequency mode when “M” or “WX” appears in the function display.
- ③ Push 5 appropriate digit keys to input the frequency.
  - Enter [1] as the 1st digit.
  - When a digit is mistakenly input, push [CLR] to clear the input, then start again.
  - Push [ENT] to enter consecutive zero digits.
  - Only [2], [5], [7] or [0] can be entered as the 5th and final digit.
- ④ To change the frequency according to the tuning step (25 kHz step), push [▲] or [▼].
  - Push and hold [▲] or [▼] to change the frequency quickly.

**EXAMPLE:** Setting the frequency to 120.000 MHz using the keypad.

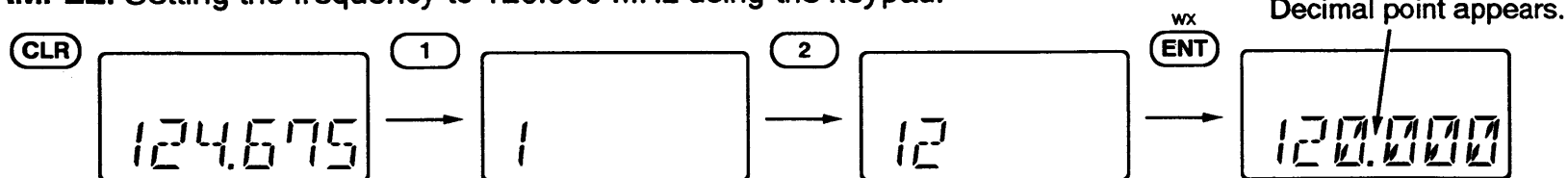

**EXAMPLE:** Setting frequency to 136.425 MHz using the keypad.

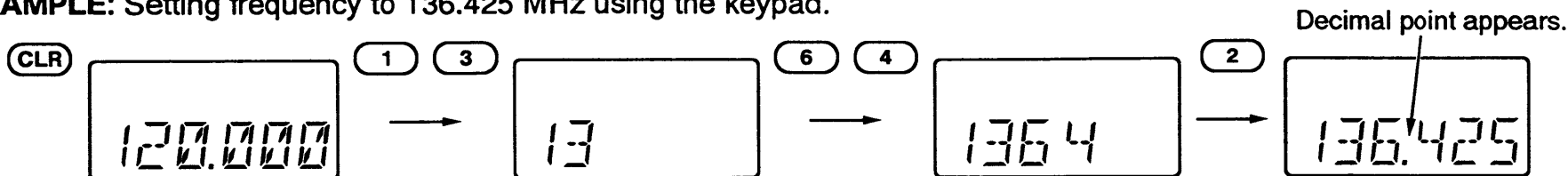

### ◇ Using the tuning dial

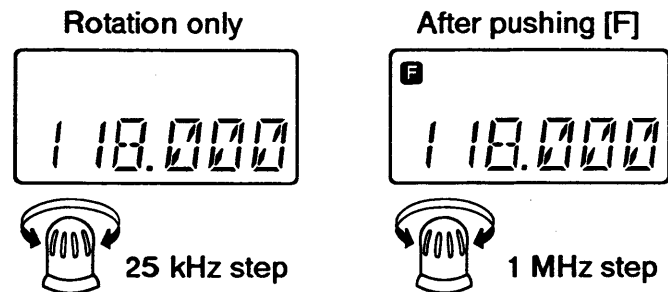

- ① Rotate [VOL] to turn power ON.
- ② Push [CLR] to select frequency mode.
- ③ Rotate the tuning dial to set the desired frequency.
- ④ To select the 1 MHz tuning step, push [F] then rotate the tuning dial.



**NOTE:** The selected frequency may take up to 2 sec. to be backed up after they are set. Wait 2 sec. before turning power OFF.

### ■ Lock function

The lock function prevents accidental frequency changes and accidental function activation.

- ① Push [F] then push [7]KEY LOCK to turn the function ON.
  - "  " appears.
- ② To turn the function OFF, repeat step ① above.
  - "  " disappears.

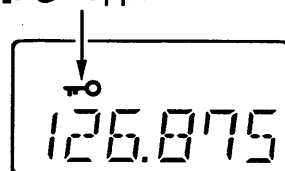

### ■ Selecting a weather channel (U.S.A. version only)

The U.S.A. version has VHF marine weather channel receiving capability for flight planning.

- ① Push [F] on the keypad.
  - "  " appears.
- ② Push [ENT·WX] to select weather channel mode.
  - "WX-" and previously selected channel number appears.
- ③ Rotate the tuning dial to set the desired channel.
  - The [▲] or [▼] key can be used.
  - To select weather channels 1–9 directly, push [1]–[9] then [ENT], or push [0] then [1]–[9].
  - To select weather channel 10 directly, push [1] then [0].
- ④ Push [CLR] or [MR] to exit weather channel mode and return to frequency or memory mode.

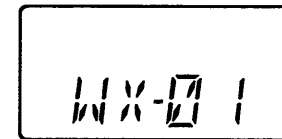

## 3 BASIC OPERATION

### ■ Receiving

- ① Rotate [SQL] maximum clockwise.
- ② Rotate [VOL] to turn power ON and adjust the audio level.
- ③ Rotate [SQL] counterclockwise until noise is muted.
  - “RX” disappears.
- ④ Set the desired frequency using the tuning dial or keypad. (pgs. 9, 10)
  - Push [LIGHT] to turn the display and keypad lighting ON, if desired.
- ⑤ Push [ANL] to reduce pulse noise such caused by engine ignition systems, if necessary.
  - “ANL” appears.
- ⑥ When a signal is received on the set frequency:
  - The receive indicator appears.
  - Squelch opens and audio is emitted from the speaker.

When the [SQL] control is set too “tight” (extremely counterclockwise), squelch may not open for weak signals. To receive weak signals, set the squelch to a “loose” (more clockwise) position.

#### ◆ Beep tone on/off

The beep tone which sounds each times a switch is pushed can be turned ON or OFF, as desired.

- Push [F] then [Ⓢ BEEP] to turn the beep tone ON or OFF.

### ■ Transmitting

**CAUTION:** Transmitting without an antenna may damage the transceiver.

**NOTE:** To prevent interference, listen on the frequency before transmitting. If the frequency is busy, wait until the channel is clear.

- ① Set the desired frequency using the tuning dial or keypad. (pgs. 9, 10)
- ② Push and hold [PTT] to transmit.
  - “TX” appears.
- ③ Speak into the microphone at a normal voice level.
  - **DO NOT** hold the transceiver too close to your mouth or speak too loudly. This may distort the signal.
- ④ Release [PTT] to return to receive.

### ■ Side tone function

When using an optional headset from the David Clark Co. via the optional OPC-499, the transceiver outputs your transmitted voice to the headset for monitoring.

## Memory channel selection

The transceiver has 50 memory channels for storage of often-used frequencies along with 6-character notes.

- ① Push [MR] to select memory mode.
- ② Select the desired memory channel.

### Using the tuning dial:

Rotate the tuning dial to select the desired memory channel.

- Only programmed memory channels appear.

### Using the keypad:

Push 2 appropriate digit keys (01–50) to select the desired memory channel.

- To select memory channels 1–9, push [1]–[9] then [ENT]; or, push [0] then [1]–[9].

### Using the ▲/▼ keys:

Push [▲] or [▼] to change the memory channel.

- Pushing [▲] or [▼] changes the memory channel continuously.

- ③ When a comment appears, push [MR] to display the programmed frequency, if desired.
- ④ To return to frequency mode, push [CLR].

Comments appear first when programmed, however, the transceiver can be programmed to show the operating frequency first by your dealer. Push [MR] to display the comment in this case.

## Transferring memory contents

This function transfers a memory channel's contents into the frequency mode. This is useful when searching for signals around a memory channel's frequency.

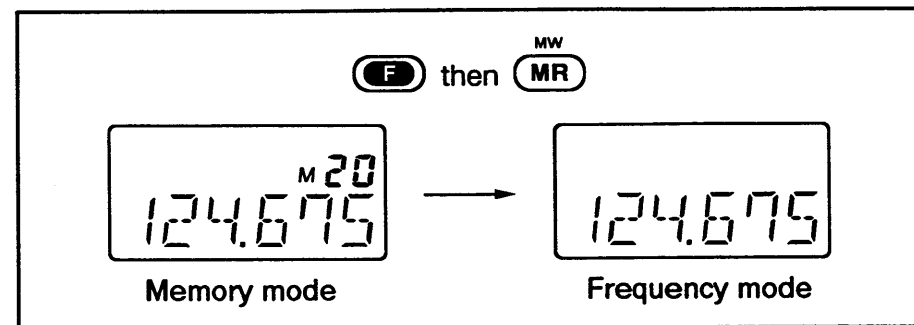

- ① Push [MR] to select memory mode.
  - "M" appears.
- ② Select the desired memory channel to be transferred using the tuning dial or keypad.
- ③ Push [F] then [MR·MW].
  - "M" disappears as frequency mode is automatically selected and the memory contents are transferred.

## 4 MEMORY OPERATION

### ■ Programming a memory channel

You can program the following data into each memory channel separately.

- Operating frequency (pgs. 9, 10)
- 6 digit comment (p. 13)
- Lockout information (p. 16)

① Set the desired frequency in frequency mode:

- Push [CLR] to select frequency mode; or, push [F] then [ENT•WX] to select a weather channel.\*
- Set the desired frequency or weather channel\* using the tuning dial or keypad.

② Push [F] then [MR•MW].

- "M" blinks.

③ Select the memory channel (01–50) to be programmed using the tuning dial or keypad.

④ Push [MR] to enter the frequency and to write a comment; push [ENT] to program the frequency and to skip writing a comment.

- Push [ENT] to program a weather channel.\* A comment cannot be programmed with a weather channel.
- Push [CLR] to cancel programming.

⑤ Set a desired comment as described at right.

⑥ Push [ENT] to program.

\* Weather channel: U.S.A. version only.

### ■ Programming a comment

The memory channel can display a 6-character comment as well as a frequency.

① Set the desired frequency in frequency mode.

② Push [F] then [MR•MW].

③ Select the memory channel to be programmed.

④ Push [MR] to enter the frequency.

⑤ Push the appropriate digit key several times to select the desired character as listed below.

Key	Character	Key	Character	Key	Character
1	1, Q, Z	2	2, A, B, C	3	3, D, E, F
4	4, G, H, I	5	5, J, K, L	6	6, M, N, O
7	7, P, R, S	8	8, T, U, V	9	9, W, X, Y
ENT	Program	0	0, Space	MR	Hyphen* <sup>1</sup>

\*<sup>1</sup> Hyphen is selectable between the 3rd and 4th digits only.

⑥ Push [ENT] to program.

#### PROGRAMMING NOTES

- Pushing [▲] or [▼] moves the cursor.
- To input characters in the same group, use [▲] to move the cursor.
- To clear the entered comment, push [CLR] before pushing [ENT].



**EXAMPLE:** Programming 125.000 MHz into memory channel 15 with "AIR-03" as a comment.

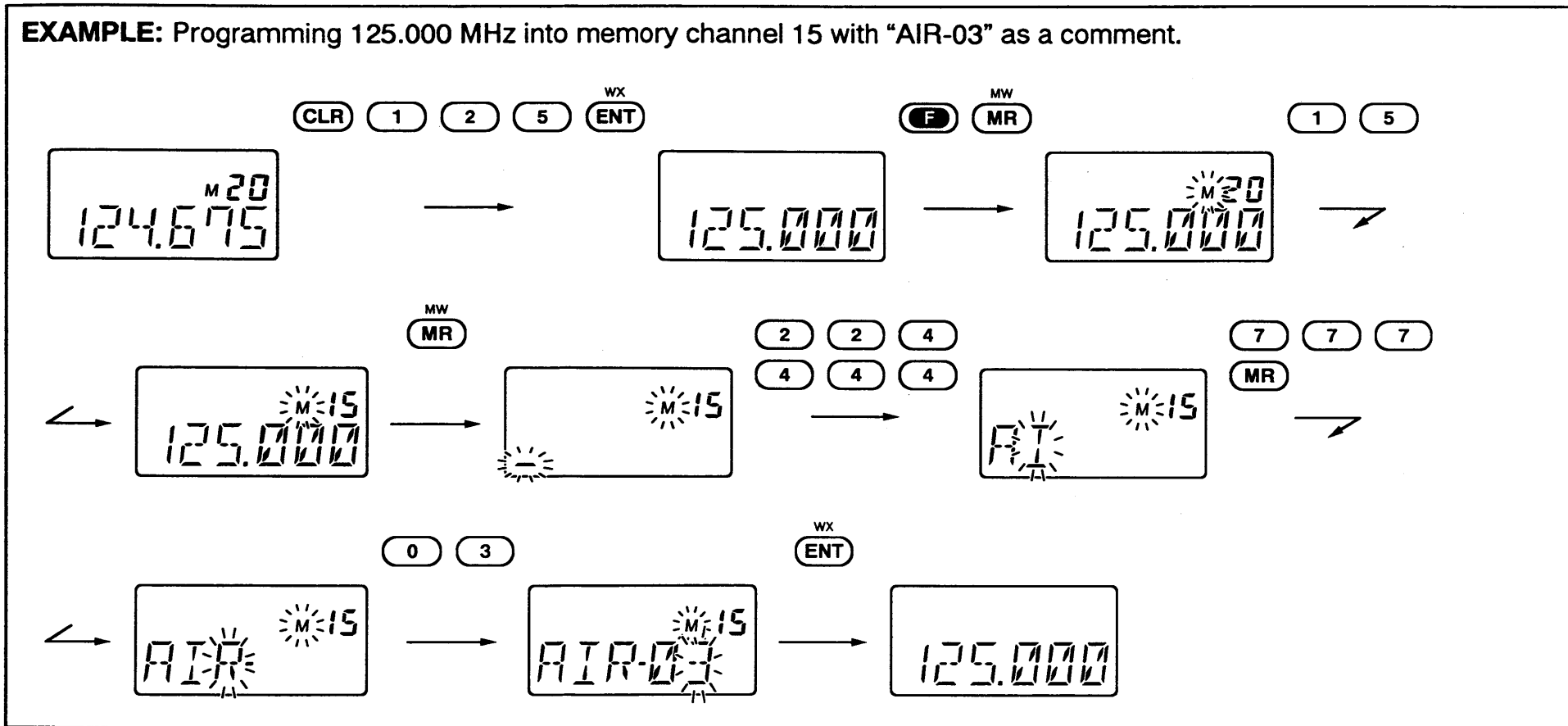

## ■ Clearing memory contents

Unwanted memory channels can be cleared. Programming over a memory channel also clears the previously programmed contents. Memory channel 1 cannot be cleared.

- ① Select a memory channel to be cleared.
- ② Push [F] then push and hold [CLR] for 1 sec.
  - "-----" appears momentarily, then the next selectable memory channel appears.

## Scan types

The U.S.A. version has 3 scan types to suit your needs. The non-U.S.A. versions have 2 scan types.

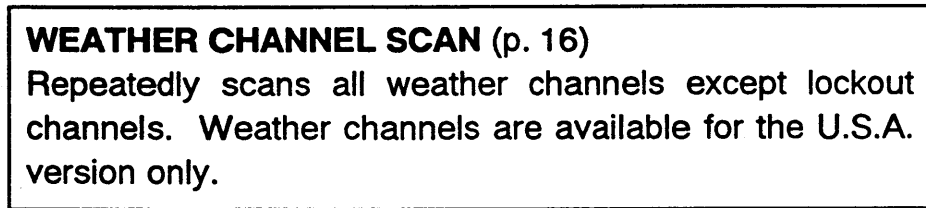
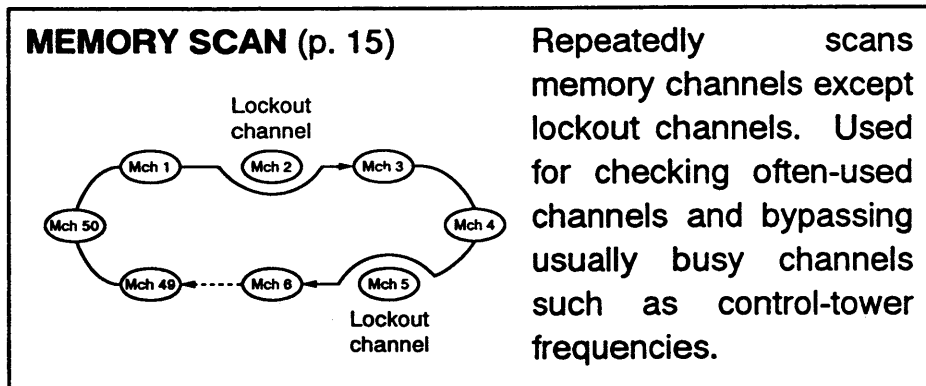
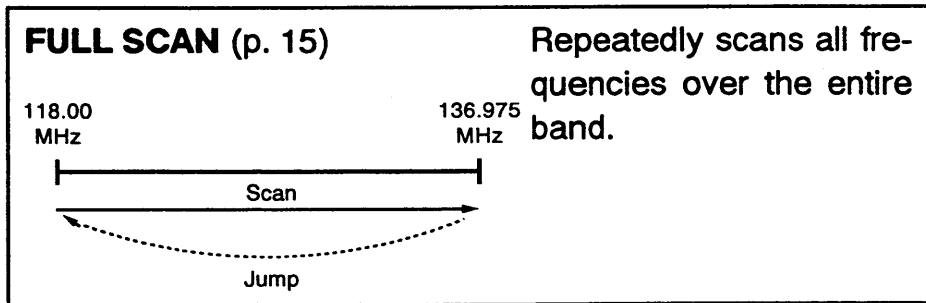

## Full scan

- ① Push [CLR] to select frequency mode.
- ② Set [SQL] to the point where noise is just muted.
- ③ Push [F] then [▲•UP SCAN] or [▼•DN SCAN] to start the scan.
  - When a signal is received, the scan pauses until it disappears. To resume the scan, rotate the tuning dial or push the [▲] or [▼] key.
  - To change the scanning direction, rotate the tuning dial or push the [▲] or [▼] key.
- ④ To stop the scan, push [CLR].

## Memory scan

- ① Push [MR] to select memory mode.
- ② Set [SQL] to the point where noise is just muted.
- ③ Push [F] then [▲•UP SCAN] or [▼•DN SCAN] to start the scan.
  - When a signal is received, the scan pauses until it disappears. To resume the scan, rotate the tuning dial or push the [▲] or [▼] key.
  - To change the scanning direction, rotate the tuning dial or push the [▲] or [▼] key.
- ④ To stop the scan, push [CLR].

## Weather channel scan

(U.S.A. version only)

- ① Push [F] then [ENT•WX] to select a weather channel.
- ② Set [SQL] to the point where noise is just muted.
- ③ Push [F] then [▲•UP SCAN] or [▼•DN SCAN] to start the scan.
  - When a signal is received, the scan pauses until it disappears. To resume the scan, rotate the tuning dial or push the [▲] or [▼] key.
  - To change the scanning direction, rotate the tuning dial or push the [▲] or [▼] key.
- ④ To stop the scan, push [CLR].

**NOTE:** A paused frequency or channel is not backed up automatically. Push [CLR] to stop the scan then wait 2 sec. before turning power OFF, otherwise, the previous frequency or channel appears when turning power ON again.

## Lockout channels

Memory and weather\* channels can be specified to be skipped for the memory and weather\* channel scans, respectively. The lockout channel function is only available during scan operation.

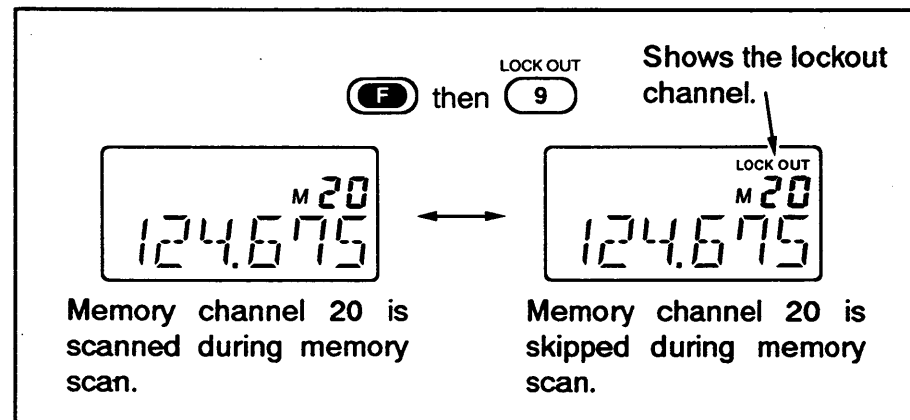

- ① Push [MR] to select memory mode; or, push [F] then [ENT•WX] to select a weather channel.\*
- ② Select the desired channel to be locked out.
- ③ Push [F] then [Ⓣ LOCK OUT].
  - "LOCK OUT" appears.
  - Lockout channels are skipped during scan.
- ④ To cancel the lockout setting, repeat above steps.

\* Weather channel: U.S.A. version only.

# 6

## TROUBLESHOOTING

PROBLEM	POSSIBLE CAUSE	SOLUTION	REF.
<ul style="list-style-type: none"> <li>No power comes on.</li> </ul>	<ul style="list-style-type: none"> <li>The battery is exhausted.</li> <li>Poor plug connection to the external DC power cable.</li> </ul>	<ul style="list-style-type: none"> <li>Charge the battery pack or place new alkaline batteries in the battery case.</li> <li>Check the connector or remove and replace the cable.</li> </ul>	pgs. 6, 7 —
<ul style="list-style-type: none"> <li>No sound comes from the speaker.</li> </ul>	<ul style="list-style-type: none"> <li>[SQL] is turned too far counterclockwise.</li> <li>A optional cable or headset is connected.</li> </ul>	<ul style="list-style-type: none"> <li>Rotate [SQL] clockwise.</li> <li>Unplug the cable or headset.</li> </ul>	p. 11 —
<ul style="list-style-type: none"> <li>Frequency cannot be set.</li> </ul>	<ul style="list-style-type: none"> <li>The lock function is activated.</li> <li>The emergency frequency is selected.</li> </ul>	<ul style="list-style-type: none"> <li>Push [F] then [⑦ KEY LOCK] to deactivate the lock function.</li> <li>Push [CLR] to select frequency mode.</li> </ul>	p. 10 p. 9
<ul style="list-style-type: none"> <li>Scan cannot be activated.</li> </ul>	<ul style="list-style-type: none"> <li>The squelch is open.</li> <li>The lock function is activated.</li> </ul>	<ul style="list-style-type: none"> <li>Rotate [SQL] counterclockwise until noise disappears.</li> <li>Push [F] then [⑦ KEY LOCK] to deactivate the lock function.</li> </ul>	p. 15 p. 10
<ul style="list-style-type: none"> <li>Frequency is not displayed.</li> </ul>	<ul style="list-style-type: none"> <li>The memory channel comments are displayed.</li> </ul>	<ul style="list-style-type: none"> <li>Push [MR] to toggle between a comment and frequency.</li> </ul>	p. 12
<ul style="list-style-type: none"> <li>Transmitting is impossible.</li> </ul>	<ul style="list-style-type: none"> <li>Weather channel is selected. (U.S.A. only)</li> </ul>	<ul style="list-style-type: none"> <li>Push [CLR] to select frequency mode.</li> </ul>	p. 10

### ◇ Resetting the CPU

**CAUTION:** Resetting the CPU clears and initializes all programmed contents such as memory contents, lockout channel settings, etc.

- While pushing [F], [0] and [ENT], turn power ON to reset the CPU.

- "CLEAR" appears momentarily, the default frequency appears and the transceiver's CPU is reset.

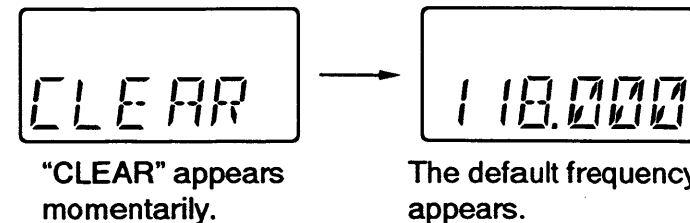

# MODE ARRANGEMENT CHART

## MEMORY MODE (p. 12)

Used for operating the transceiver using memory channel contents. 50 memory channels are available for programming.

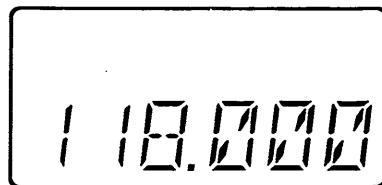
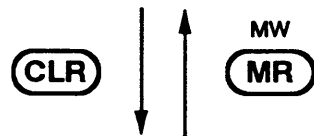
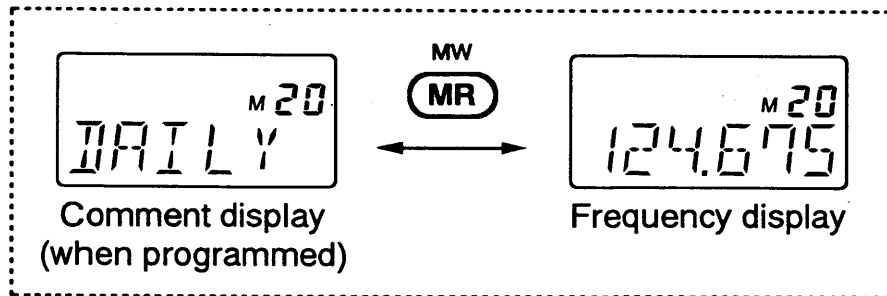

**FREQUENCY MODE (p. 9)**  
Used for frequency setting and normal operations over the entire band.

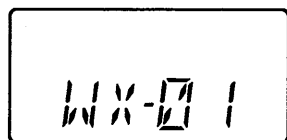
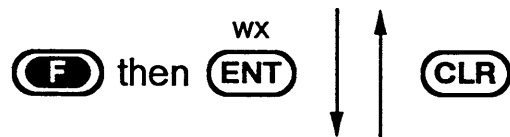

**WEATHER CHANNEL (p. 10)**  
Used for receiving weather channels. Available for the U.S.A. version only.

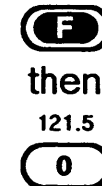

## EMERGENCY FREQUENCY (p. 9)

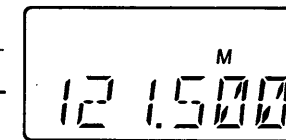

Used for operating on the 121.5 MHz emergency frequency. Can be accessed even when the lock function is in use.



**■ GENERAL**

- Frequency coverage :
  - Transmit/receive : 118.000–136.975 MHz
  - Receive : Weather channels 01–10\*<sup>1</sup>
- Mode :
  - Transmit/receive : AM (6K00A3E)
  - Receive : FM (16K0G3E)\*<sup>1</sup>
- Tuning step increment : 25 kHz
- Antenna impedance : 50 Ω (nominal)
- Power supply : 12–15 V DC
- requirement (negative ground)
- Current drain (at 12 V DC, typical):
  - Transmit : 1.0 A
  - Receive : Rated audio 240 mA
  - : Squelched 55 mA
- Usable temperature range: –10 °C to +50 °C ;  
+14 °F to +122 °F
- Frequency stability : ± 20 ppm (–10 °C to +50 °C)
- Dimensions : 57(W) × 153(H) × 35(D) mm  
(projections not included) 2 1/4(W) × 6 1/32(H) × 1 3/8(D) in
- Weight : 465 g; 16.4 oz  
(with CM-166 and antenna)

**■ TRANSMITTER**

- Selectable output power\*<sup>2</sup> : 5.0 W (PEP power)  
(at 12 V DC, typical) 1.5 W (Carrier power)
- Modulation system : Low level modulation

- Spurious emissions\*<sup>2</sup> : Less than –60 dB
- External microphone : 150 Ω
- impedance

**■ RECEIVER**

- Receive system : Double-conversion  
superheterodyne
- Intermediate frequencies : 1st 35.8 MHz  
2nd 455 kHz
- Sensitivity\*<sup>2</sup> : Less than 1.0 μV  
(for 6 dB S/N with 1 kHz, 30% modulation)
- Squelch sensitivity : Less than 1.0 μV  
(at threshold)
- Selectivity : More than 8 kHz/–6 dB  
Less than 25 kHz/–60 dB
- Spurious response : More than 60 dB  
rejection ratio\*<sup>2</sup>
- Noise and hum : More than 25 dB
- Audio output power\*<sup>2</sup> : More than 0.6 W at 10%  
(at 12 V DC) distortion with the 8 Ω load.
- Audio output impedance : 8 Ω

\*<sup>1</sup> Weather channels and FM mode: U.S.A. version only

\*<sup>2</sup> Specifications guaranteed at a transceiver temperature of +25 °C  
(+77 °F).

**All stated specifications are subject to change without notice or obligation.**

**BM-112U/E WALL CHARGER**

(U.S.A./Europe version)

Regularly charges the CM-166 in approx. 15 hrs.

**BM-95V WALL CHARGER + OPC-507**

**JACK ADAPTER (Australia version)**

Regularly charges the CM-166 in approx. 15 hrs.

**CM-166 BATTERY PACK**

12 V 600 mAh Ni-Cd rechargeable battery pack for approx. 5 hours operation.\* Same as supplied with non-U.K. versions.

\* 5% Tx/5% Rx/90% Squelched

**CM-167 BATTERY CASE**

Battery case for R6 (AA) size alkaline batteries × 10.

**LC-122 CARRYING CASE**

Fits the transceiver with the supplied CM-166.

**OPC-499 HEADSET ADAPTER CABLE**

Allows you to connect a headset from the David Clark Co. Provides the side tone function.

**OPC-515L DC POWER CABLE**

For operation and charging with a 12–15 V DC power supply.

**BC-79 DESKTOP CHARGER +  
AD-50 DESKTOP CHARGER ADAPTER**

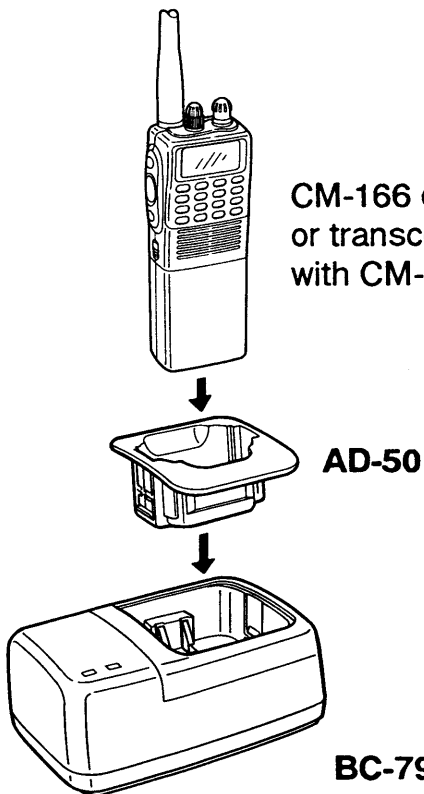

CM-166 only  
or transceiver  
with CM-166

AD-50

BC-79

Rapidly charges the CM-166 in approx. 1.5 hrs. An AC adapter is packed with the BC-79. An optional CP-13/L or OPC-288/L can be used instead of the supplied AC adapter.

**CP-17L CIGARETTE LIGHTER CABLE**

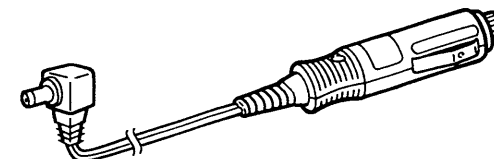

For operation and charging with a 12 V cigarette lighter socket.

**Count on us!**

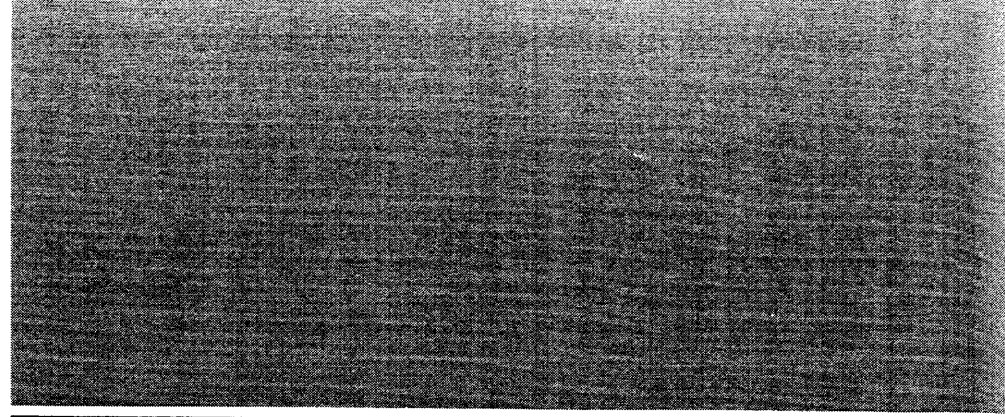

A-5317S-1EX  
Printed in Japan  
Copyright © 1994 by Icom Inc.

**Icom Inc.**  
6-9-16, Kamihigashi, Hirano-ku, Osaka 547, Japan

---